

New Product

Intelligent Control | Network LED Display

Ionizing Air Blower

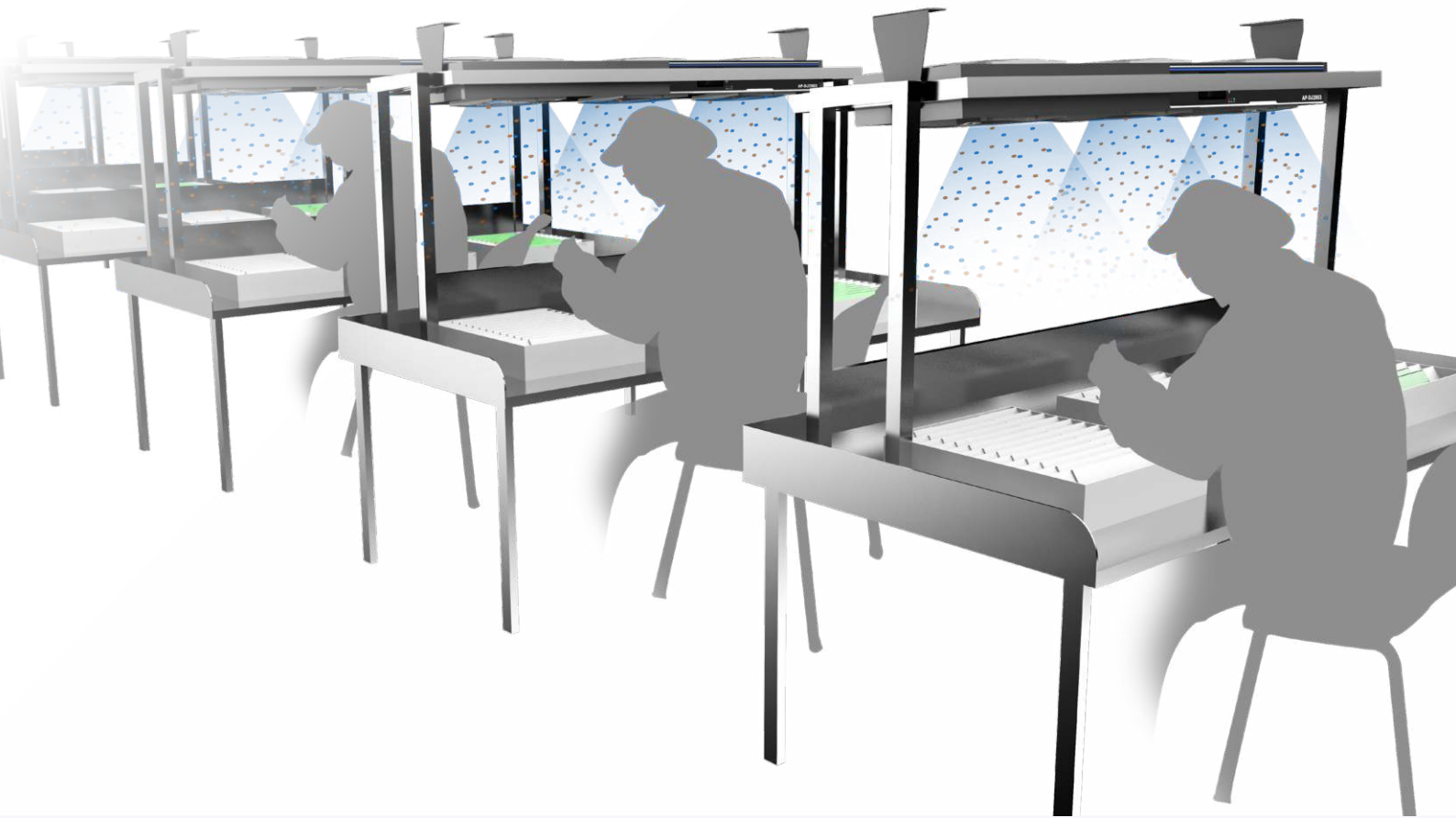



Suitable for electronics, optoelectronics,
semiconductor and other industries

Effectively solve the problems
caused by static electricity



Static removal

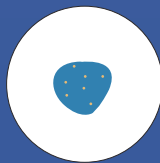

Prevent adhesion of objects

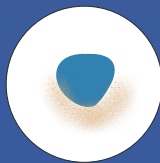

Prevent material splash

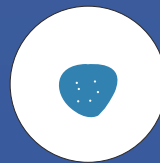

Prevent static electricity

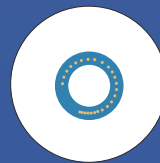

Prevent blockage of feeder

Network Monitoring

Monitoring the working status of
ionizing air blower online

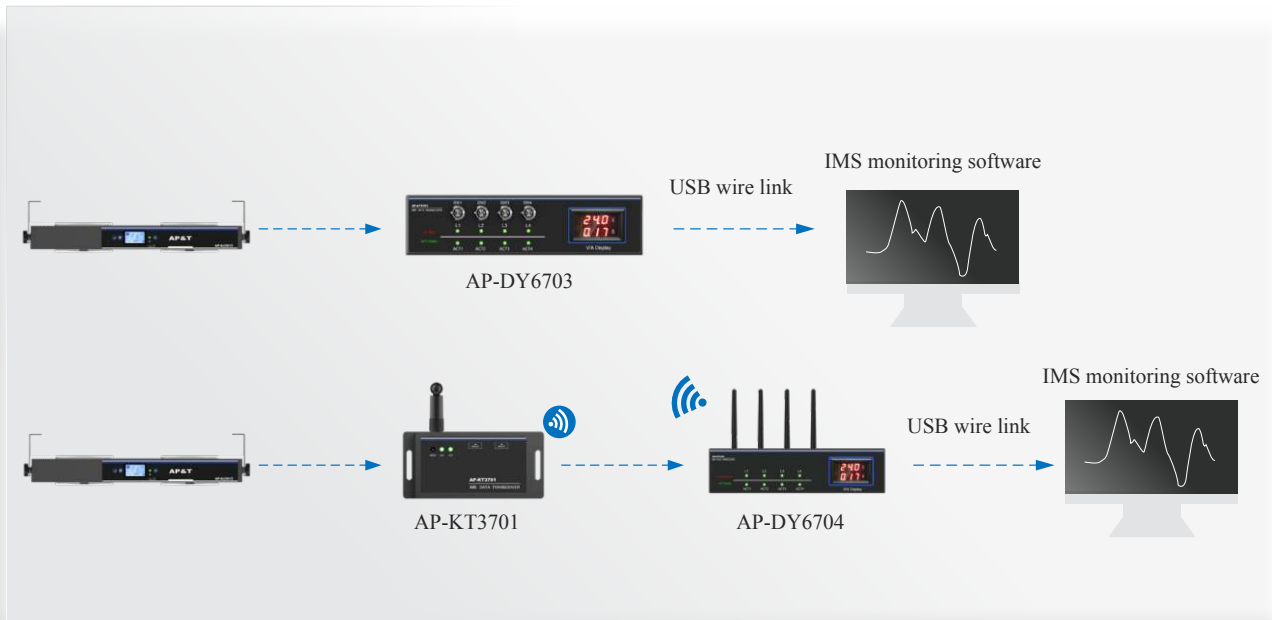
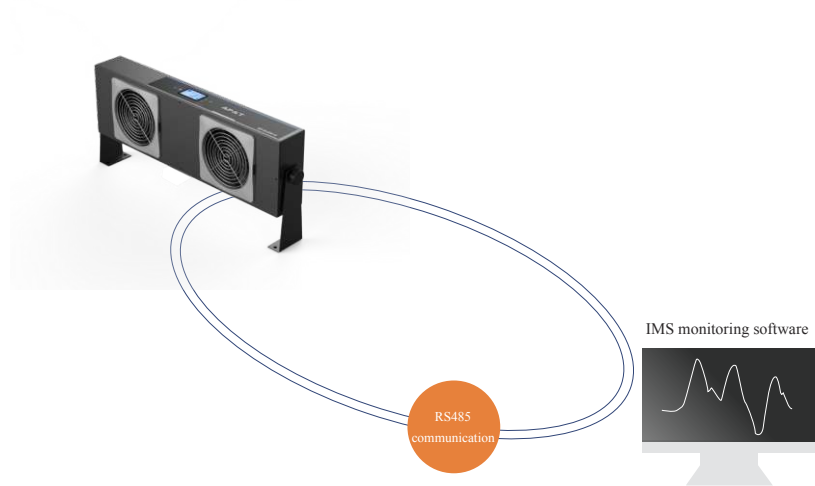

Intelligent Remote Control

Cleaning time /Air volume output/Ion balance adjustable



Cleaning time setting

Set a reminder for the cleaning time at will. Blue light flashes indicates cleaning is required. The electrode needle cleaning cycle should be set according to the working environment when using the ionizing air blower. Cleaning cycle should be shorten appropriately in environment with more moisture and dust.

Air volume output adjustable

Fan speed in five gears. Adjust the air volume according to the installation distance of the static eliminator and the status of the target object.

Ion balance adjustable

The ion balance voltage can be adjusted by adjusting the negative high voltage amplitude remotely.

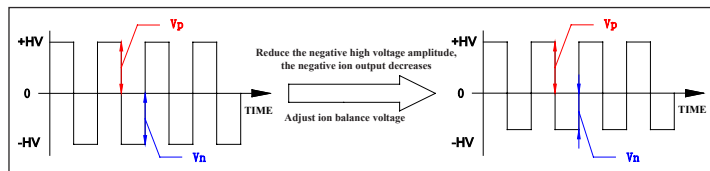

Button Function instructions

Function	Symbol	Operation instructions
Unlock		Unlock before adjusting operating parameters; 30s delay if any key is pressed, exit and re-locked if no key is pressed.
Run / Pause		Device starts running when power is on. Press "STOP" to standby and no high voltage output. Press "RUN" again and the device will start working.
Clean		Press the button to clean the needle once.
Adjust clean time	CT _{TH} → +/-	Press CT _{TH} first, and then press +/- to increase or decrease the cleaning cycle. Minimum adjustment unit 1H.
Adjust air volume	CFM → +/-	Press CFM first, then press +/-, air volume from high to low is 1,2,3,4,5.
Adjust ion balance	IB _N → +/-	Press IB _N first, then press +/- to adjust the ion balance voltage.
Confirm	CAL → OK	Note: Press CAL first, then press OK to confirm after adjusting the output parameter; otherwise, false alarms are likely to occur.
Reset	CAL →	Reset (150Hz、50%、4H) : Press CAL first, then press
Press IB _N first, then press + when the positive voltage on flat panel charge detector or object surface is high, press IB _N first, then press - when the negative voltage on flat panel charge detector or object surface is high until the ion balance reaches the ideal status.		

Pulse DC

Discharge effect is better compare to frequency AC ionizing air blower

Pulse DC VS Traditional AC

Pulse DC method generate ions with two polarity by applying "+" and "-" high voltage alternately on positive and negative electrode needles.

Compared with power frequency AC method, the utilization rate of ion generation is higher. And its static elimination ability can be exerted no matter in short or long distance. In addition, the discharge frequency can be adjusted, which can extend the discharge distance. The output ratio of positive and negative ions can be adjusted, which is convenient for intelligent control.

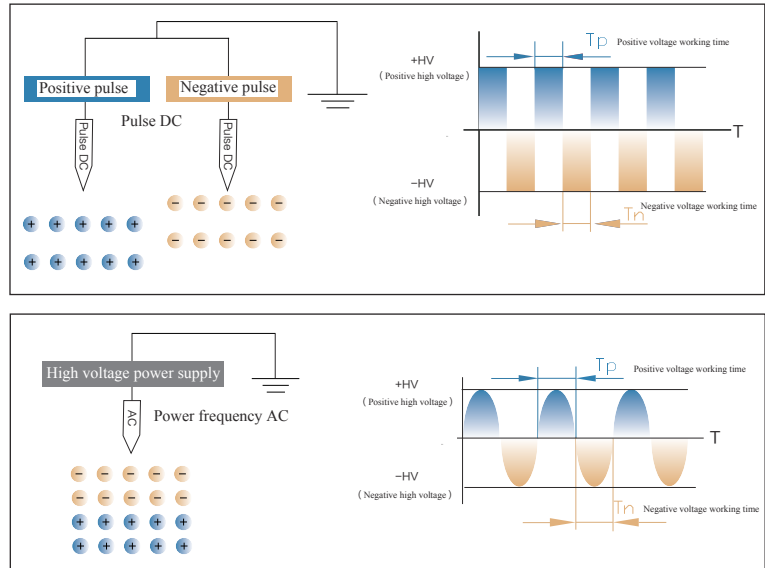

3 situations of static electricity on the surface of the object



Decrease T_p so that the positive voltage acting capacity becomes smaller and the acting time becomes shorter. Less positive ions and more negative ions output to neutralize the excess positive charge on the surface of the object.



Increase T_p so that the positive voltage acting capacity becomes greater and the acting time becomes longer. More positive ions and less negative ions output to neutralize the excess negative charge on the surface of the object.



Adjust the duty ratio $[T_p/(T_p+T_n)]$ to an appropriate ratio and send out the same amount of positive and negative ions to neutralize the static electricity on the surface of the object.

High Efficiency Static Removal

Keep a clean production environment and stay away from static electricity

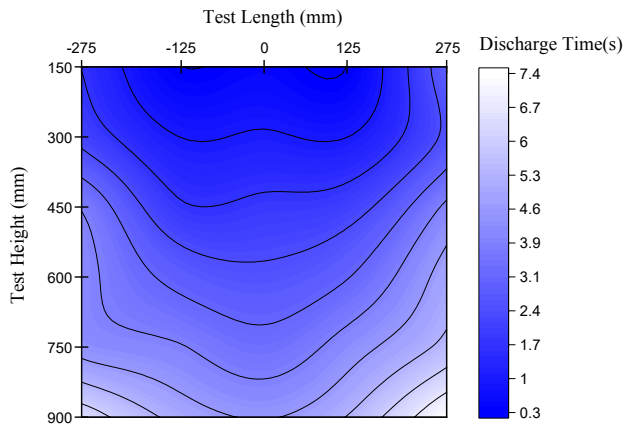

Discharge time distribution diagram of AP-DJ2812

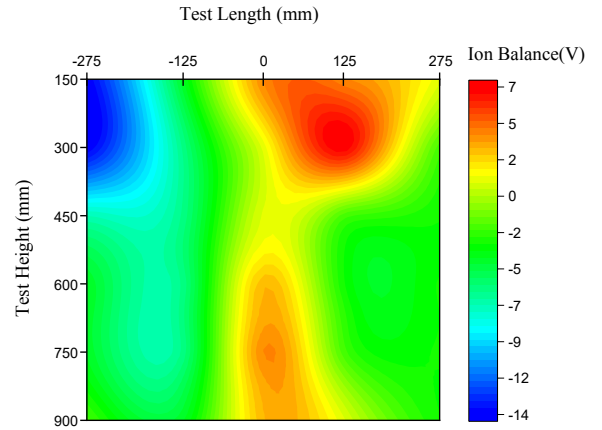

Ion balance distribution diagram of AP-DJ2812

Note: The 0 point of the test length is the center position of the air blower
Test standard: ANSI/ESD.STM3.1, SJ/T 11446—2013
Test instrument: Trek charge plate tester
Test voltage: $\pm 1000V \rightarrow \pm 100V$ attenuation
Test environment: humidity 50 \pm 5%; temperature 23 \pm 3 $^{\circ}C$

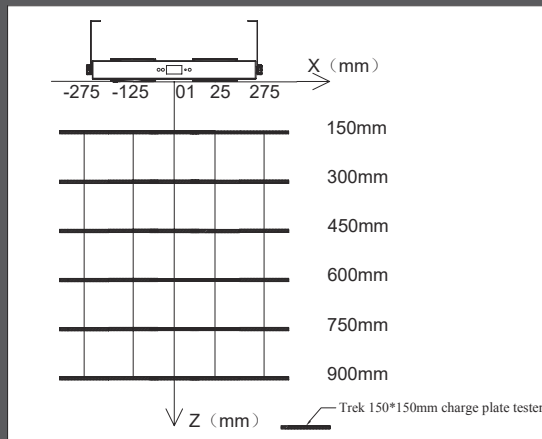

Test bearing chart of air blower

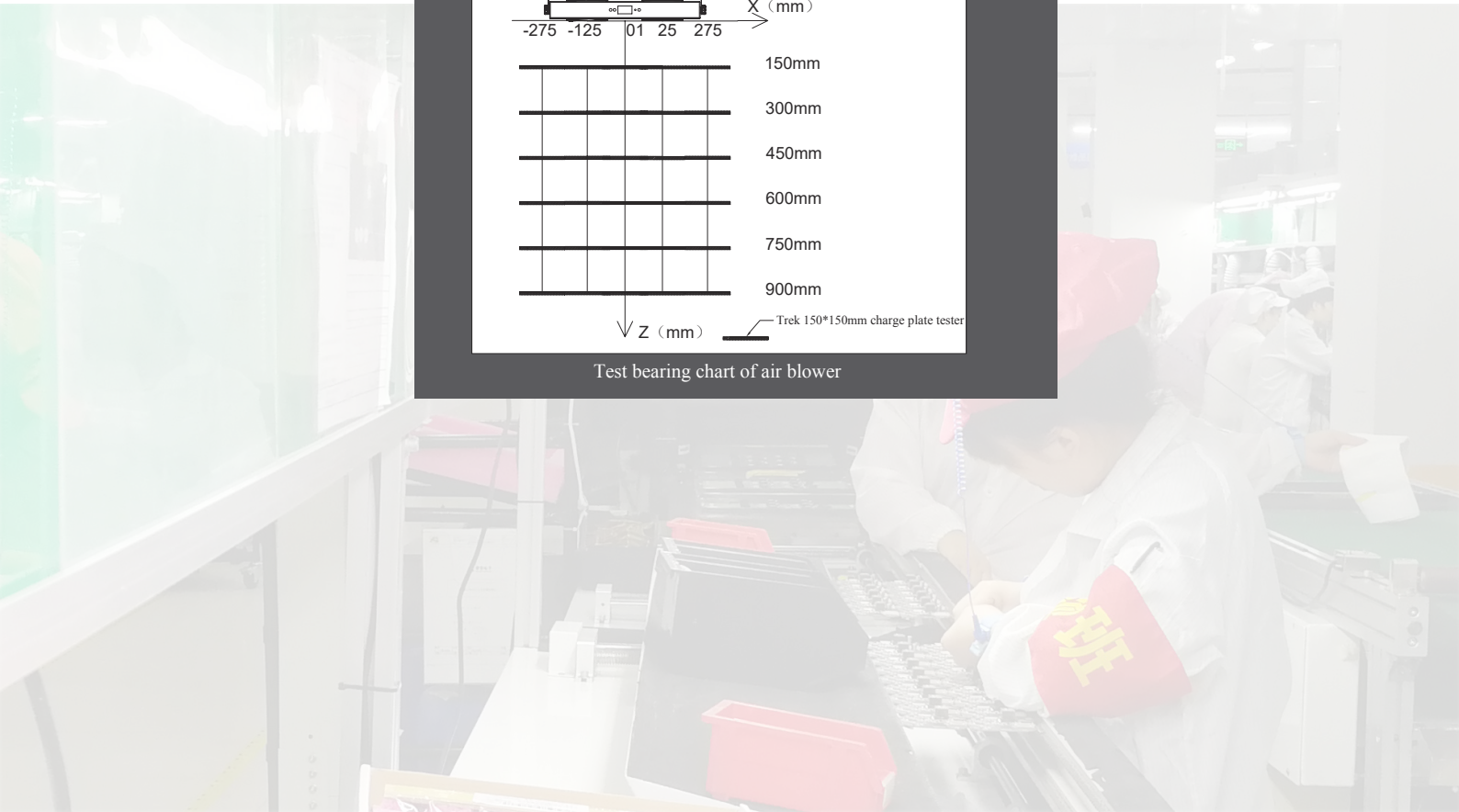

Features

Safe / Easy to use / Durable



No.1

Magnetic net cover

The power is cut off immediately and the fan is in the standby (STOP) state when the net cover is separated, which is convenient for disassembly and maintenance.

No.2

High air volume fan five speed adjustment

Stable performance and air volume output 1.45 times higher than ordinary fans.

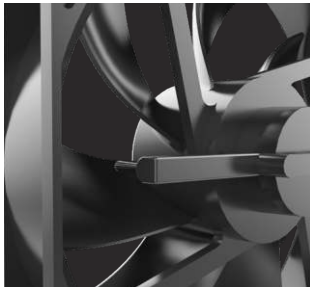
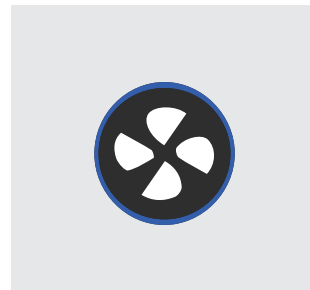

No.3

Built-in cleaning brush

Automatic needle brushing function when start up. By default, the needle is automatically brushed every 4 hours for manual cleaning and maintenance free.

No.4

Fault alarm

Display screen show fault alarm and LED red light alarm when the fan, ion balance, and high voltage breakdown.

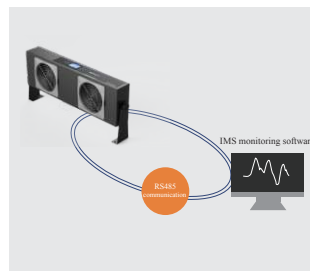

No.5

Network Monitoring

Wired network communication realisable and monitor the working status of the air blower.

Features

Safe / Easy to use / Durable

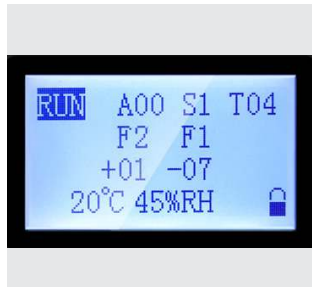

No.6

LED display

LED display shows the equipment address (e.g.A00), wind speed gear (e.g.S1), cleaning cycle (e.g.T04), temperature and humidity, cleaning indication (Cleaning), fan fault alarm (Fan Fault!!) and HV fault alarm (HV Fault!!). The balance voltage of each air outlet displays in real time, which alarms (Ion Fault!!!) when the set threshold is exceeded, alarms fault when the high voltage is 0V.

No.7

8 Tungsten electrode needles

Multiple air outlets, 8 needles per air outlet with large amount of ion generation and longer life time compared to titanium and silicon.

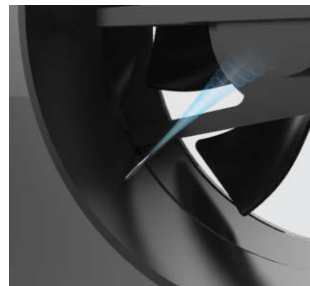

No.8

CE certification

CE certified with electromagnetic protection function and no electromagnetic interference to other equipment. It can also effectively avoid external electromagnetic interference affecting the normal operation of the air blower which is a high-security and high-reliability static eliminator.

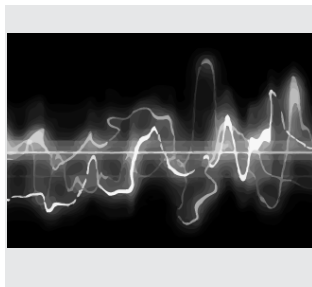

No.9

Ion self balancing function

The self balancing range is $\pm 10V$ and the balance voltage can be displayed in real time.

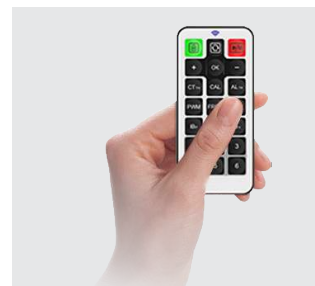
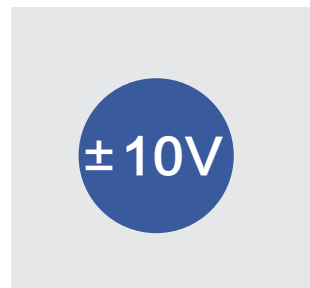

No.10

Intelligent remote control

The negative high voltage amplitude is adjustable, which can be used to adjust the ion balance voltage.

Ion output characteristics can be adjusted by remote control.

Product Use

Panel functions/specification/dimensions

Panel functions

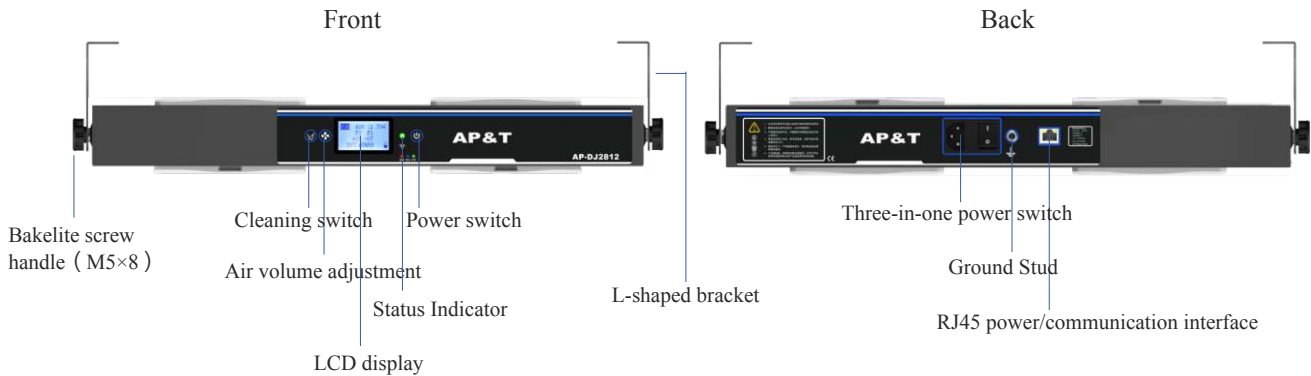

LCD parameter display description

Display content	Description	Sample graph
RUN/STOP	Run / Pause	
A00	Current working address of the device: 00	Green light: Running
S4	Current wind speed gear: 4	Blue light: Pause / Standby
T04	Cleaning cycle: 04 (Unit: H)	Blue light flashes: Cleaning
F2 F1	Current air outlet (There are 1 to 4 air outlets for AP-DJ28 series ionizing air blower)	
+07 -08	The balance voltage of the corresponding air outlet	
28°C	Temperature of the current operating environment	
62%RH	Humidity of the current operating environment	
Cleaning...	Cleaning indication	
Fan Fault!!!	Fan fault alarm	Red light: Fan fault alarm
HV Warning!!!	High voltage fault alarm	Red light flashes: HV alarm

Power interface cable function information

1, 2	Orange/White-orange	VCC : +24VDC
3	Blue	RS485+B
4	White-blue	RS485+A
5	Green	GND
6	White-green	GND
7	Brown	VTH : Sensor threshold alarm HVAL : Eliminator high voltage alarm
8	White-brown	ACT : Sensor/eliminator power-on indication Clean : Eliminator cleaning indication
9	Metal shield	PE

The output wiring diagrams of pins 7 and 8 are as follows:

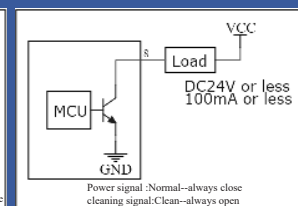
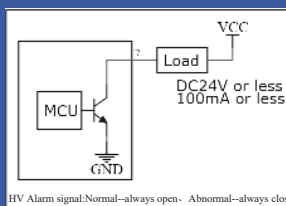

Specification

Model	AP-DJ2812
Input voltage	DC 24V (RJ45 interface) / Three in one socket (220VAC 50/60Hz)
Output voltage	DC±4KV → ±6KV
Power	21W
Ion emission	Pulse DC
Emitter electrode	Tungsten alloy
Discharge range	750*550mm (L*W)
Air volume	≤ 135CFM*2
Noise	Single air outlet≤ 58dBA (1000mm away from the air outlet)
Ozone thickness	≤ 0.05ppm (150mm away from the air outlet)
Ion balance	≤ ±15V
Discharge speed	≤ 2.5S (450mm away from the air outlet)
Status indicator	Power on/clean operation—blue light flashes;
	Normal work—green light (always under monitoring status);
	Fan fault alarm—red light always on;
	Balance voltage exceed alarm-red light flashes;
	High voltage fault alarm-red light flashes ;
	Infrared debugging/cleaning prompt-blue light flashing
Communication method	RS485
Signal output	RS485 (115200bps,8,1,n,n) ≥ 20ms
	Collector open circuit: < 50V,100mA
Working temperature	0°C -50°C
Working humidity	< 70%RH
Dimensions (L*W*H)	510*154*70mm (Ionizing Air Blower body size)
Shell material	Aluminum powder spraying
Installation accessories	1 pair of L-shaped iron powder spraying mounting brackets, 1 pair of bakelite screw handles(M5×8)
Power adapter	INPUT: AC100—240V 50/60Hz; (This is preferred for simultaneous power supply)
	OUTPUT: DC24V 2A (dual RJ45 interface)
Net weight(Including power cord and bracket)	2.60KG
Warranty	1Year
Certification	CE

Dimensions

Unit: mm

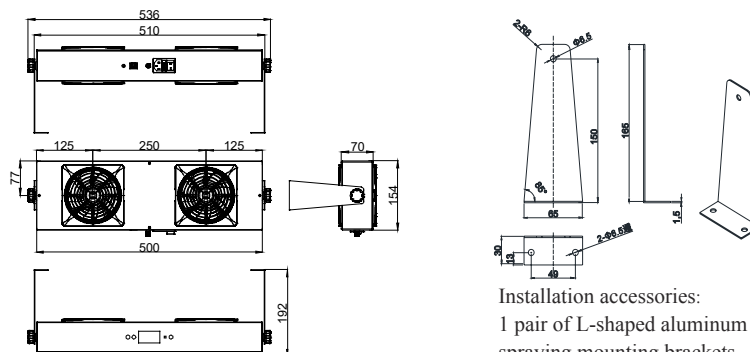

Installation accessories:

- 1 pair of L-shaped aluminum powder spraying mounting brackets,
- 1 pair of bakelite screw handles (M5×8)

Products Use

Installation steps/technical tips/Packing accessories

Installation steps

1. Install the ionizing air blower and the matching power adapter firmly in the best discharge position.
2. Insert the power network cable into the adapter and the ionizing air blower RJ45 network port, and insert the three-phase power cable of the adapter into the row socket.
3. The overhead air blower can also be directly powered by 220VAC. The actual power supply is 220VAC when both 220VAC and 24VDC are connected to the fan.
4. Touch the power switch on the front panel of ionizing air blower. It will automatically brush the needle after starting and the fan works normally when the indicator light is green.

Technical tips



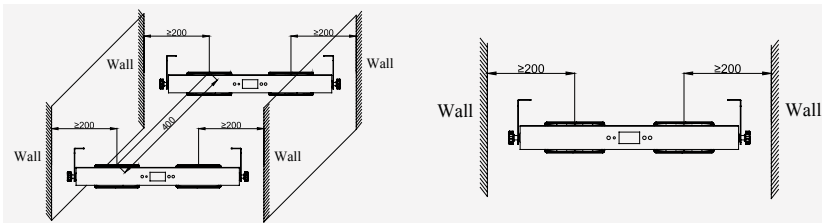

1. Place the ionizing air blower in the work area where static electricity is to be eliminated and the installation angle is perpendicular to the surface of the charged body.
2. Ionizing air blower should be at least 300mm away from the metal conductor and metal grounding body. The ionizing air blower must be reliably connected to the ground wire.
3. Two ionizing air blowers should be installed side by side with an interval of more than 400mm and more than 200mm away from obstacles such as walls.

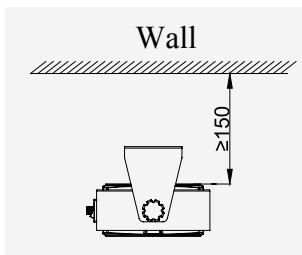

4. The air inlet is at least 150mm away from the wall.



Packing accessories

Part name	Picture	Part No.	Specification	Q'TY
Power adapter		AP2930003	GRT-240200: DC24V 2A, Dual-port output, size: 123*61*40.5mm (L*W*H)	1
National standard power cord		8YXG25110	Standard 1.8m, Optional 3m/5m	1
Power cable		8WXI00004	Standard 2.5m, Optional 5m/10m	1
Remote control		AP2253011	IR remote control, 84×38mm	1

▲ Safety warning

1. Please read the instruction manual carefully before installing and using this equipment.
2. The whole set of equipment must be reliably grounded during use, and the connection resistance of the electrical connection to the AC equipment ground should be less than 1 ohm.
3. Do not use this equipment in environment where humidity is > 70%.
4. It is strictly forbidden to use this equipment in flammable and explosive environments.
5. Unauthorized disassembly of the product is strictly prohibited, internal maintenance and repair must be performed by professionals.
6. The product is strictly prohibited to touch liquid during use, otherwise an abnormality may occur and cause electric shock or fire.
7. Power must be turned off during inspecting or replacing the product, otherwise it may cause electric shock or fire.
8. The product is specially designed to eliminate static electricity. It is strictly forbidden to use it for other purposes. Any abnormal use may cause machine failure, electric shock, fire and other accidents.
9. It is strictly forbidden to touch the electrode needles when power is on, otherwise it is easy to cause malfunctions and electric shock accidents.
10. The electrode needle is a sharp metal object, please use it with care.
11. Please check the specifications of the power supply before powering on the product. Any power supply that does not meet the specifications will cause damage to the product.
12. Please check the product power cord/communication cord regularly and replace it immediately if it is damaged. Otherwise it is easy to cause problems such as electric leakage, poor communication, and abnormal operation.

▲ Trouble shooting

NO	Faults	Reasons	Solutions
1	The indicator on the fan panel is off	Poor contact of the power cable	Check whether the power cable is in good condition and securely connected
		Power supply mismatch	Confirm the power supply specification (INPUT: 100—240VAC 50/60Hz; OUTPUT: 24VDC 2000mA)
2	The electrostatic removal performance decreased obviously.	Discharge needle is polluted and damaged	Clean or replace the discharge needle
		Ionizing air blower is set incorrectly	Confirm the best installation location
		The cleaning brush covers the electrode needle	Brush the needle manually with the remote control, or shut down and restart to keep the cleaning brush away from the electrode needle
3	The electrostatic removal performance decreased	There are conductors or other ionizing air blower around	Remove (moving) conductors or other ionizing air blowers
4	High voltage/ion balance alarm (Panel indicator light flashes red)	Electromagnetic interference	Turn off the power switch / unplug the power cable, restart the ionizing air blower
		Abnormal discharge	Confirm whether the electrode needle is close to or touching the metal conductor, and remove foreign objects
		No power supply for high voltage module	Return to factory for maintenance
		High voltage module is damaged	Return to factory for maintenance
		Ion balance alarm	Use the remote control to re-adjust after cleaning the electrode and net cover
	The cleaning brush covers the electrode needle	Brush the needle manually with the remote control, or shut down and restart to keep the cleaning brush away from the electrode needle	
5	Fan alarm (Panel indicator red light always on)	Fan fault	Return to factory for maintenance
		The fan power supply or control circuit is damaged	Return to factory for maintenance
6	Unable to discharge	High voltage module is damaged	Return to factory for maintenance
		Main-board chip is damaged	Return to factory for maintenance
		Poor grounding / no grounding / chip damage caused by wrong power supply circuit	Check the grounding of the ionizing air blower and plant equipment, and return to the factory for maintenance
7	The display is off or flickering	Abnormal discharge	Return to factory for maintenance
		High voltage module is damaged	Return to factory for maintenance
		Poor grounding or wrong product power supply circuit	Check the grounding of the ionizing air blower and plant equipment, and return to the factory for maintenance
8	The product is smoky or burnt	The high-voltage module is damaged or the insulation of the discharge bracket is damaged	Return to factory for maintenance

Maintenance

1. The fan should be cleaned and maintained in time according to the use environment and the required electrostatic protection requirements in order to ensure the good performance of the product. That is, gently remove the dust on the electrode, discharge bracket, fan and metal mesh cover with electrostatic brush, dust-free cotton swab, dust-free cloth dipped in anhydrous alcohol. Note:
 - A. Operation must be done 10 minutes after power cut off
 - B. The cleaning cycle of the electrode needle should be set according to the working environment during use of the fan. It should be appropriately reduced in the environment with more humid and dusty.
 - C. The fan must be powered on after alcohol is completely volatilized after cleaning. No other organic solvent can be used to clean the fan.
 - D. The alloy electrode is a consumable product which is not included in the scope of warranty and will be charged for replacement when repairing.
2. Do not press or rotate the control buttons on the fan panel too hard; otherwise, the device will be permanently damaged.
3. If the working indicator light on the front panel of the fan is off or red, it should be stopped and repaired by professional maintenance personnel. It can be used only after the electrical performance index is normal.

After-sales service

AP-DJ2812 ionizing air blower has undergone rigorous testing and aging treatment before ex-work. Its performance has completely reached the relevant indicators marked in the usage instruction.

AP&T makes a commitment to the customer that any defective parts inspected by AP&T will be repaired or replaced free of charge within one year from the date of purchase. However, this commitment does not apply to:

1. The device is incorrectly used or installed.
2. Damage caused by negligence or accident during use;
3. Modified, disassembled or repaired by other service departments not authorized by Anping Company.

AP&T shall not be liable for any incorrect use of the products except for repair or replacement of parts as specified above.

AP&T®

AP&T

Professional electrostatic intelligent monitoring/analysis
and elimination solution provider

Speciality Creates Value

Shanghai Anping Static Technology Co.,Ltd

Tel : +86-21-64517676

Fax : +86-21-64517673

Postcode : 200233

Website : www.ap-static.com

Address : 3/F, Building 27, No.69, Guiqing Road, Shanghai, China



AP&T