

AP&T®

AP-DB1223

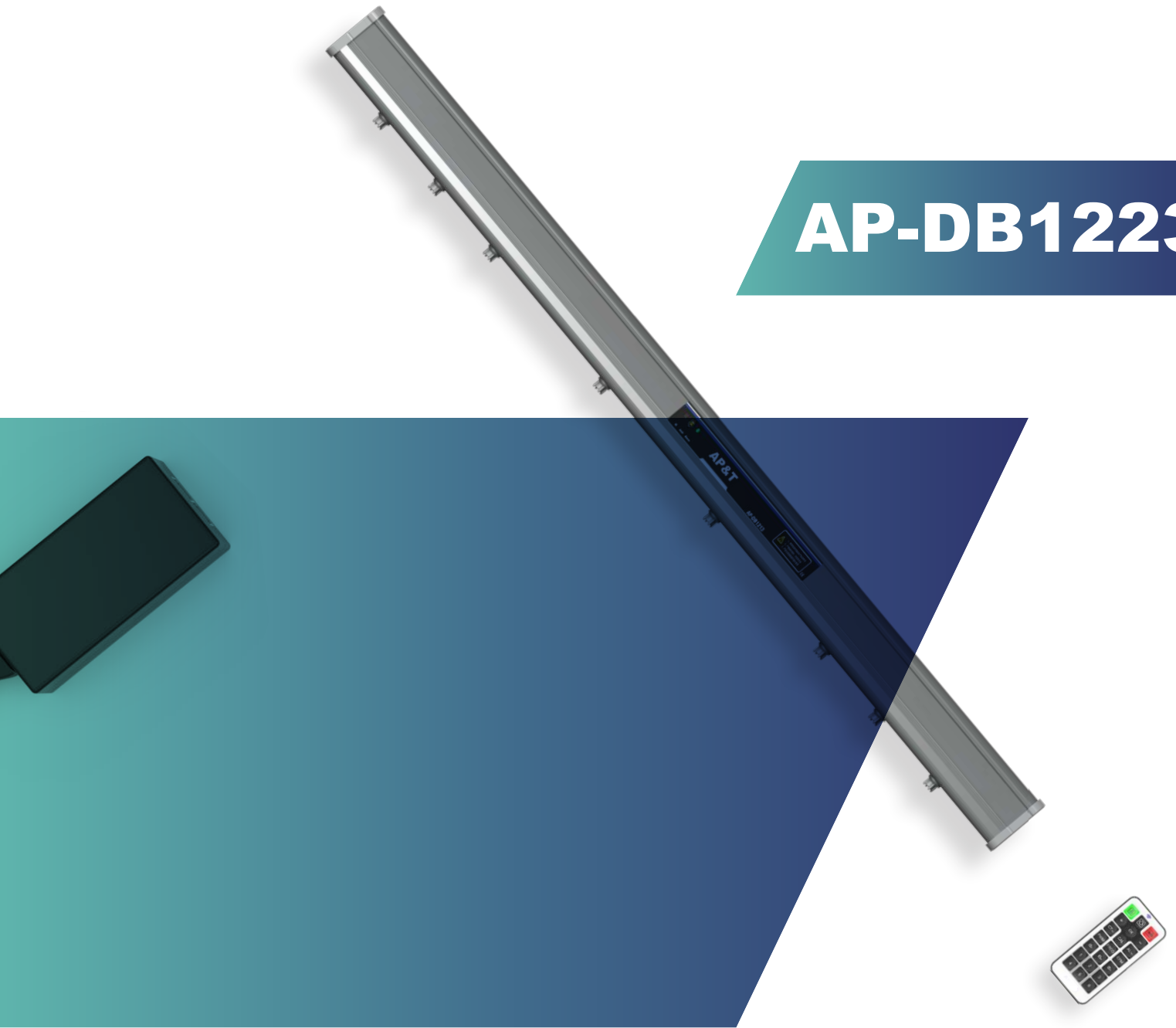

Distant Space Static Removal Ion Bar

Shanghai Anping Static Technology Co.,Ltd



Suitable for electronics, optoelectronics,
semiconductor and other industries

Effectively solve the problems
caused by static electricity



Static removal

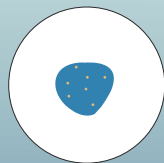

Prevent adhesion of objects

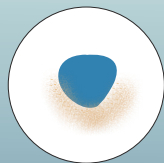

Prevent material splash

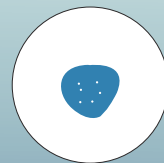

Prevent static electricity

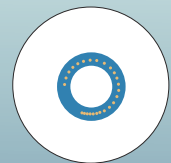

Prevent blockage of feeder

High Efficiency Static Removal

Keep a clean production environment and stay away from static electricity

AP-DB1223 space ion bar is a bar-type static elimination device developed and produced by Anping Company to eliminate static electricity and maintain static balance in clean spaces, which adopts a DC high voltage power supply and a special silicon-based electrode acting on the positive and negative coupling electrode needles through the positive and negative DC high voltages alternately to generate corona discharge, ionize air molecules, and generate a large number of positive and negative air ions to neutralize the partial unbalanced electrostatic charge in the space to achieve efficient and reliable maintenance of the electrostatic balance in the space, reduce particle adhesion in the space, make polluting particles easy to be filtered out by the air conditioning purification system, and reduce particle pollution in the space.

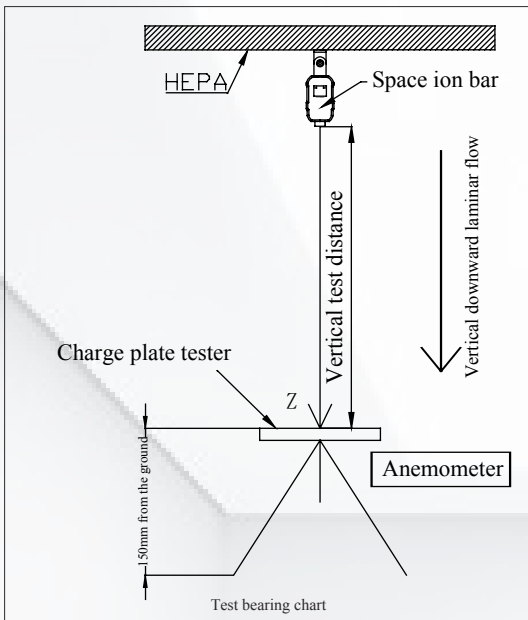

Vertical center test data		
Test height: Z=600		
Positive discharge time(s)	Negative discharge time(s)	Balance voltage AVG(V)
1.8	1.8	-16.8
Test height: Z=900		
Positive discharge time(s)	Negative discharge time(s)	Balance voltage AVG(V)
5.2	6.4	1.4
Test height: Z=1200		
Positive discharge time(s)	Negative discharge time(s)	Balance voltage AVG(V)
9	11	4.9

Test standard: ANSI/ESD.STM3.1, SJ/T 11446—2013

Test instrument: Trek charge plate tester

Test voltage: $\pm 1000V \rightarrow \pm 100V$ attenuation

Test environment: humidity $50 \pm 5\%$; temperature $23 \pm 3^\circ C$

HEPA (FFU) Airflow speed: 0.35-0.5m/s;

Working frequency: 5Hz

Note: The following data is for reference only. The discharge data will be different due to the different use environment and working parameters.

Other test data (discharge range, ion bar width direction):

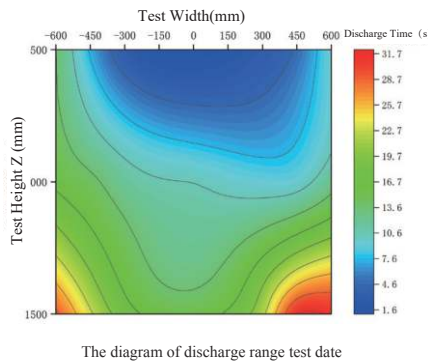
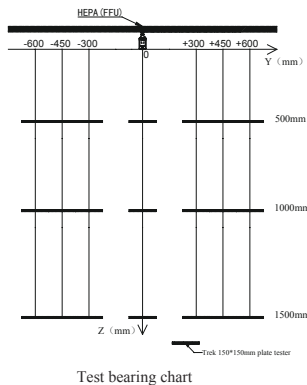

The figure below shows the approximate size of the discharge coverage space of the space ion bar within 60s (L is the length of the ion rod):

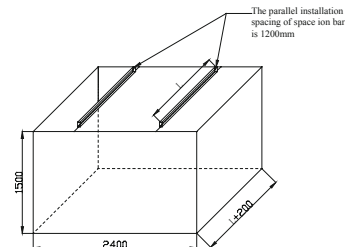

Intelligent Remote Control

Ion balance/ion output frequency adjustable



Button function instructions

Function	Symbol	Operation instructions
Unlock		Unlock before adjusting operating parameters
Run / Pause		Device starts running when power is on. Press "STOP" to standby and no high voltage output. Press "RUN" again and the device will start working.
Adjust cleaning cycle	CT _{TH} → +/-	Press CT _{TH} first, then press +/- to increase or decrease the cleaning cycle. The default cleaning cycle is 15 days, and the adjustment range is 1-60 days; The cleaning function will alarm and the power will be restarted to restore the set time when the countdown is 0 days; the cleaning function will be invalid when it is set to 0 days.
Adjust frequency	FREQ → +/-	Press FREQ first, then press +/- to increase or decrease the output frequency of positive and negative ions (cycle setting). Note: This adjustment function can only be effective if the coding switch is in C or D position.
Adjust balance	IB _N → +/-	Press IB _N first, then press + when the positive voltage on flat panel detector or discharge object surface is high, press IB _N first, then press - when the negative voltage on flat panel detector or discharge object surface is high until the ion balance reaches the ideal status.
Confirm	CAL → OK	Note: Press CAL first, then press OK to confirm after adjusting the output parameter; otherwise, false alarms are likely to occur.
Reset	CAL →	Reset, Press CAL first, then press

Note: The discharge effect will be improved if the ion balance (output) is adjusted to the opposite polarity of the charged object in the case where the static charge with a certain polarity is attached to the static charge removal object in advance. However, be careful not to charge the object back in this case.

Intelligent Remote Control

Ion balance/ion output frequency adjustable

The ion balance voltage can be adjusted by adjusting the negative high voltage amplitude remotely.

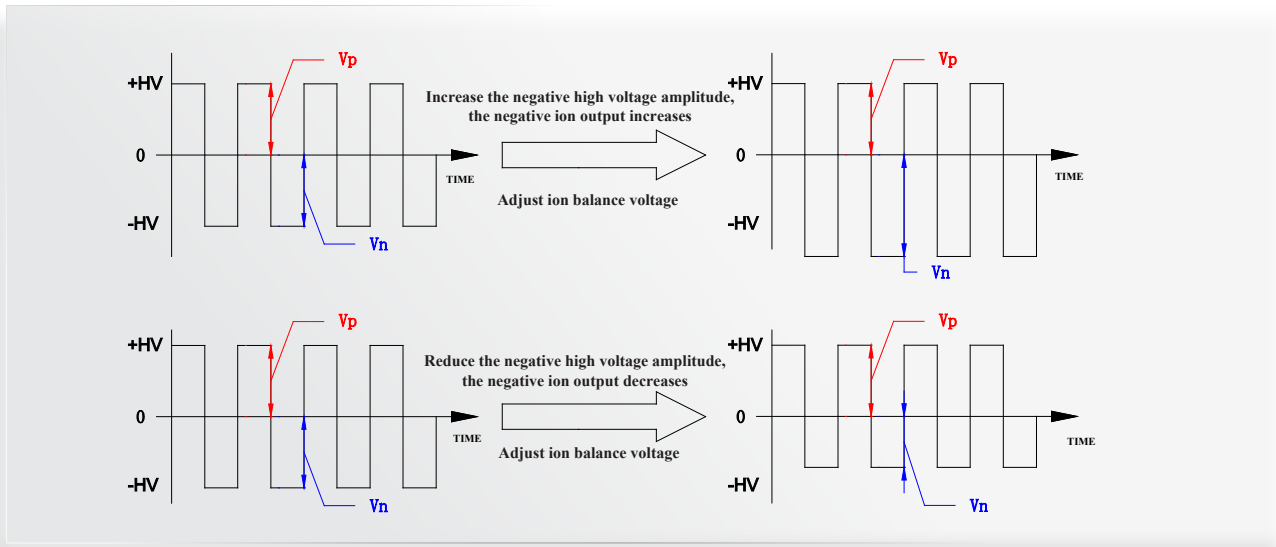

The output frequency of positive and negative ion is adjustable, which is suitable for different discharge distance to achieve faster discharge speed.

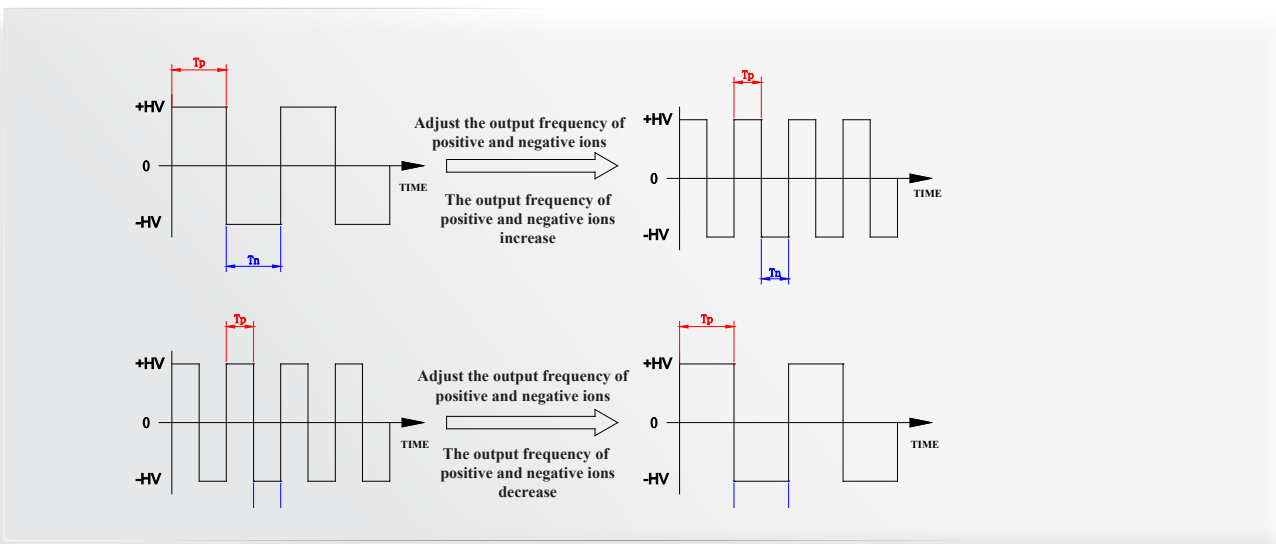

Pulse DC

Discharge effect is better compare to power frequency AC ion bar

Pulse DC VS traditional AC

Pulse DC method generate ions with two polarity by applying "+" and "-" high voltage alternately on each electrode needles.

Compared with power frequency AC method, the utilization rate of ion generation is higher. And its static elimination ability can be exerted no matter in short or long distance. In addition, the discharge frequency can be adjusted, which can extend the discharge distance. The output ratio of positive and negative ions can be adjusted, which is convenient for intelligent control.

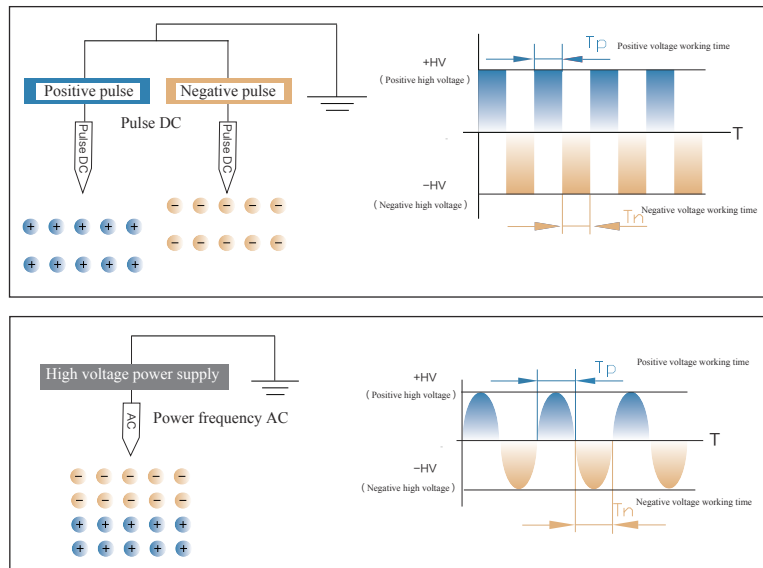

Features

Safe / Easy to use / Durable



No.1

Special discharge structure design

Dedicated Si electrode configuration which is suitable for the elimination of space static electricity.

No.2

Working status indicator

Green light: Normal work
Red light: Abnormal high voltage
Blue light: Infrared adjustment / pause / cleaning indication



No.3

Electroshock-proof

Protection against human electro-shock.

No.4

Intelligent remote control

Ion output characteristics can be adjusted by remote control.



Features

Safe / Easy to use / Durable



No.5

7 kinds of length specifications

There are 7 kinds of length specifications which can meet the requirements of different ionization range and save the quantity and workload of adaptor and ion bar installed.

No.6

End to end connection in series to simplify wiring

The product can be switched on from end to end to simplify wiring. Each adaptor power supply can load up to 2 space bars.

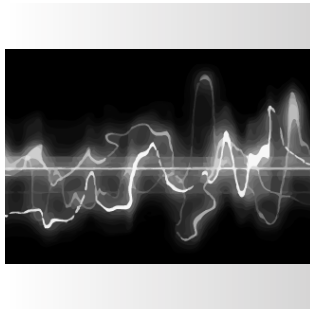
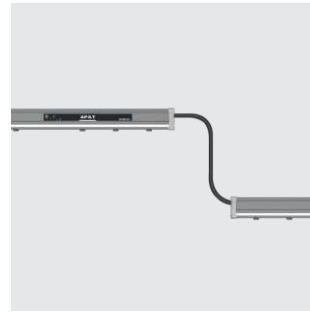

No.7

CE certification

It can effectively avoid external electromagnetic interference affecting the normal operation of the ion bar which is a high-security and high-reliability static eliminator.

Product Use

Product details / product size / product specification

Product details

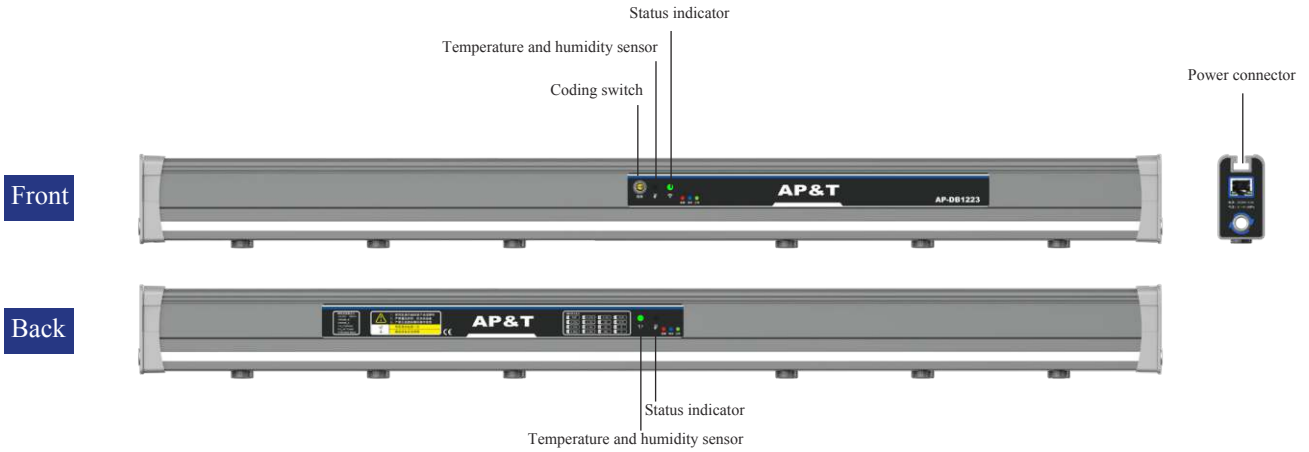

Product size

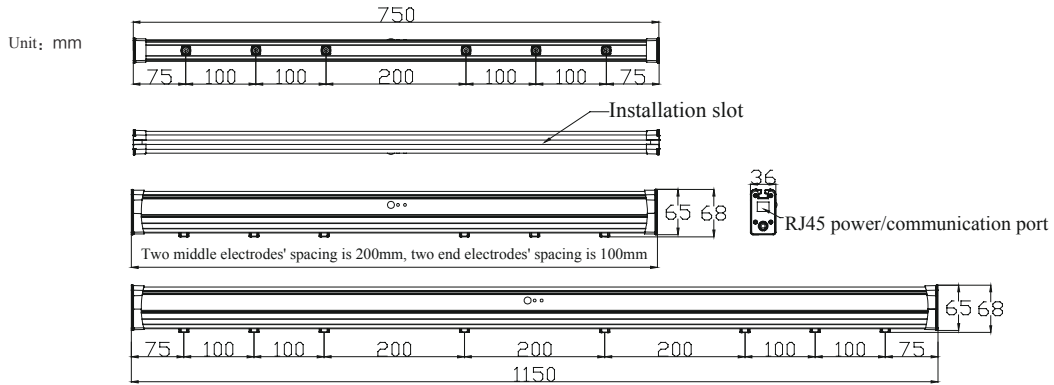

Total length of ion bar $L=750+400*n$, (n=0,1,2,3,4,5,6)

Ion bar dimensions

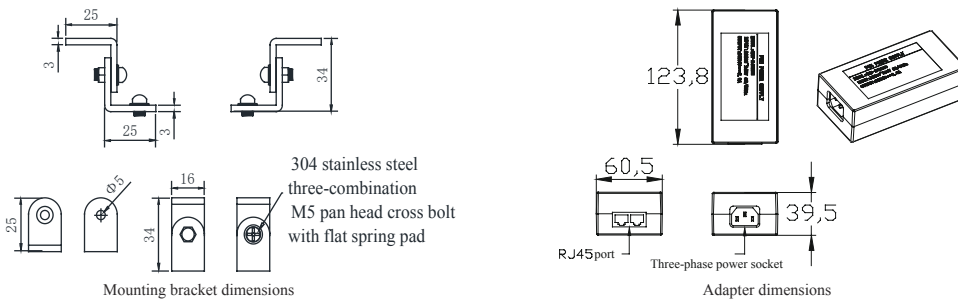

Product specification

Model	AP-DB1223
Input voltage	DC 24V
Power	< 5.5W
Working voltage	±10KV-15KV
Ion emission	Pulse DC
Emitter electrode	Si
Output frequency	0.01, 0.03, 0.05, 0.07, 0.1, 0.3, 0.5, 0.7, 1, 3, 5Hz; ex-work setting: 5Hz, parameters can be adjusted by coding switch or remote control. The ion balance has been calibrated at the factory which can be adjusted again with a charge plate tester by selecting the appropriate operating frequency according to the on-site usage.
Duty ratio	5%—95% (Parameters can be adjusted by remote control)
Ozone thickness	< 0.1ppm (50mm away from the emitter electrode)
Alarm indicator	Green light—Normal work, Red light—Abnormal high voltage, Blue light—Debugging/cleaning indication RJ45 port indicator: Green light—Power-on indication, Orange light—Flashing with working frequency
Status monitoring	RS485 (115200bps,8,1,n,n) ≥ 20ms Collector open circuit: < 50V,100mA
Working temperature	0°C -50°C
Working humidity	< 70%
Dimensions	L*W*H: {750, 1150, 1550...→ 3150}*36*68mm
Bar material	Flame retardant PVC、ABS
Packaging accessories	180°rotatable mounting bracket, M5-12*12*4 square nut
Power adapter	GRT-240200; DC24V 2A, dual network port output, 123*61*40.5mm (L*W*H)
Power cord	2.5m
Warranty	1 Year
Certification	CE

Products Use

Step of use/Installation position/Packing accessories

Step of use

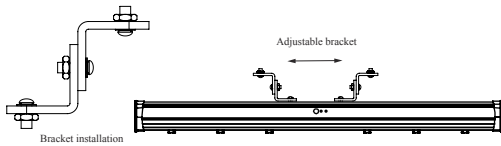

1

Take out ion bar, power adapter, power cable, stainless steel mounting bracket and other accessories from the packing box and install the stainless steel mounting bracket on the mounting slot of the ion bar base. Select the best static discharge position and install the bar body and the supporting power supply firmly.

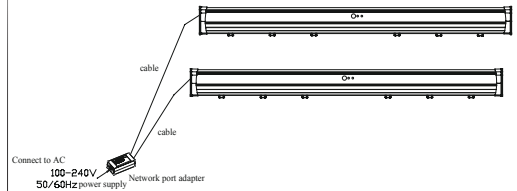

2

Insert one end of the power cord into the socket of the power adapter, and the other end into the power port on the bar body. The port wiring information is shown in the table below.

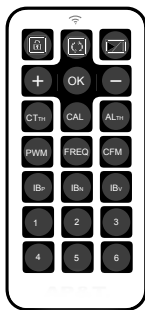

3

The network port power indicator light on and the panel indicator light green shows ion bar working normally. Adjust the appropriate voltage output parameters to output positive and negative ions to neutralize the electrostatic charge in the space.

Network port cable function information

1	Orange	+24VDC
2	White-orange	+24VDC
3	Blue	RS485+B
4	White-blue	RS485+A
5	Green	GND
6	White-green	GND
7	Brown	HV _{AL} : Eliminator high voltage alarm
8	White-brown	ACT: Eliminator power-on indication Clean: Eliminator cleaning indication
9	Metal shield	PE

The output wiring diagrams of pins 7 and 8 are as follows:

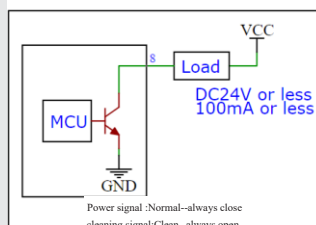
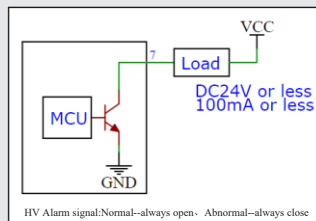

AP-DB1223 coding switch

0:	Pause / modify address
1:	0.01HZ
2:	0.03HZ
3:	0.05HZ
4:	0.07HZ
5:	0.1HZ
6:	0.3HZ
7:	0.5HZ
8:	0.7HZ
9:	1HZ
A:	3HZ
B:	5HZ
C:	Remote control / terminal control
D:	Remote control / terminal control
E:	Negative high voltage output (P:95%、N:5%-105HZ)
F:	Positive high voltage output (N:95%、P:5%-105HZ)

Indicator function

Blue light:	Infrared adjustment/pause/cleaning indication
Green light:	Normal work
Red light:	Alarm indication



NPN function

7:	High voltage indication
8:	Power-on indication, cleaning indication

Installation position

- 1) Place the ion bar in the working area where static electricity is to be eliminated and the installation angle is perpendicular to the surface of the charged body.
- 2) Ion bar should be at least 10cm away from the metal conductor and metal grounding body around the electrode and the bar body must be reliably connected to the ground wire.

Packing accessories

Part name	Picture	Part No.	Specification	Qty
Power adapter		AP2930003	GRT-240200 DC24V 2A P/N:1/2+ 5/6- network metal PE	1
National standard power cord		8YXG25110	Standard 1.8m, optional 3m/5m	1
Double-end crystal head black shield ethernet cable		8WXI00004	Standard 2.5m, optional 5m/10m	1
Single-end crystal head black shield ethernet cable		8WXI00002	FUTP CAT.5E 26AWG 4Pair Jacket PVC OD:5.6±0.2mm bag packed	Optional
L-shaped stainless steel mounting bracket		AP8038005	Height 25mm /Width 16mm/ Thickness 3mm/Aperture 5mm (measured 4.8mm)	4
M5 Flake Slider Nut		AP8933000	M5*12*12*4	2
304 stainless steel spring washer		AP8943000	M5	6
304 stainless steel flat gasket		AP8946004	M5	6
304 stainless steel pan head Phillips screw		AP8900001	M5*12	6
Hex nuts		1LML05000	M5	4
Needle holder		AP6620006	—	—
Remote control		AP2253011	Infrared remote control (L*W*H : 85.76*39.76*6.66)	1

 Safety warning

1. Please read the instruction manual carefully before installing and using this equipment.
2. The whole set of equipment must be reliably grounded during use, otherwise it is easy to cause abnormality or even damage to the ion bar.
3. Do not use this equipment in environment where humidity is > 70%.
4. It is strictly forbidden to use this equipment in flammable and explosive environments.
5. Unauthorized disassembly of the product is strictly prohibited, internal maintenance and repair must be performed by professionals.
6. It is strictly forbidden to touch liquid during use, otherwise an abnormality may occur and cause electric shock or fire.
7. Power must be turned off during inspecting or replacing the product, otherwise it may cause electric shock or fire.
8. The product is ventilated with dry and clean air or nitrogen which will work abnormally or be damaged if the gas source contains water or grease.
9. The product is specially designed to eliminate static electricity. It is strictly forbidden to use it for other purposes. Any abnormal use may cause machine failure, electric shock, fire and other accidents.
10. Its strictly forbidden to touch the electrode needles when power is on, otherwise it is easy to cause malfunctions and electric shock accidents.
11. The electrode needle is a sharp metal object, please use it with care.
12. Please check the specifications of the power supply before powering on the product. Any power supply that does not meet the specifications will cause damage to the product.
13. Please check the product power cord/communication cord regularly and replace it immediately if it is damaged. Otherwise it is easy to cause problems such as electric leakage, poor communication, and abnormal operation.

 Trouble shooting

NO.	Problems	Reasons	Solutions
1	The indicator on the label panel is off	Poor contact of the power cable	Check whether the power cable is in good condition and securely connected
		Power supply mismatch	Confirm the power supply specification (INPUT: 100—240VAC 50/60Hz; OUTPUT: 24VDC 2000mA)
2	The indicator of the RJ45 interface is off (green light indicates power-on, orange light flashes with working frequency)	Poor contact of the power cable	Check whether the power cable is in good condition and securely connected
		Power supply mismatch	Confirm the power supply specification (INPUT: 100—240VAC 50/60Hz; OUTPUT: 24VDC 2000mA)
		No power supply, power-on indicator-green light is off	Check the power supply cable
		The mainboard is abnormal-the orange light is off	Return to factory for maintenance
3	The electrostatic removal performance decreased	Discharge needle is polluted and damaged	Clean or replace the discharge needle
		Whether the discharge seat is tightened	Confirm the discharge seat is tightened
		Bearing set of ion bar is improper	Confirm the best bearing set
		There are conductors or other ion bar around	Remove (moving) conductors or other ion bar
4	Panel indicator red light on	Electromagnetic interference	Turn off the power switch / unplug the power cable, restart the ion bar
		Abnormal discharge	Confirm the installation location and stay away from surrounding conductors, confirm whether the electrode needle is close to or touching the metal conductor and remove foreign objects
		No power supply for high voltage module	Return to factory for maintenance
		High voltage module is damaged	Return to factory for maintenance
5	Unable to discharge	High voltage module is damaged	Return to factory for maintenance
		Main-board chip is damaged	Return to factory for maintenance
		Main-board chip is damaged caused by poor grounding or no grounding	Check the grounding of the ion bar and plant equipment, and return to the factory for maintenance
6	The product is smoky or burnt	High voltage module is damaged or insulation of the discharge seat is damaged	Return to factory for maintenance

Maintenance

The ion bar should be cleaned and maintained in time according to the use environment and the required electrostatic protection requirements in order to ensure the good performance of the product. That is, unscrew the electrode needle assembly into an ultrasonic cleaner and ultrasonically clean for 10 minutes. Ultrasonic cleaning will remove dust particles attached to the electrode needles as well as most of the white crystal attachments which will improve its performance significantly.

1、 Note:

A、 peration must be done 10 minutes after power cut off.

B、 The ultrasonic cleaning fluid is pure water, not corrosive solvents such as circuit board cleaning agents, otherwise it will corrode the plastic electrode holder.

C、 The ion bar must be powered on after moisture is completely volatilized after cleaning.

2、 If the working indicator light of the power plug-in port on the end cover of the bar body and the panel indicator light are off, it should be stopped and repaired by professional maintenance personnel. It can be used only after the electrical performance index is normal.

After-sales service

AP-DB1223 space ion bar has undergone rigorous testing and aging treatment before ex-work. Its performance has completely reached the relevant indicators marked in the usage instruction.

1. AP&T makes a commitment to the customer that any defective parts inspected by AP&T will be repaired or replaced free of charge within one year from the date of purchase. However, this commitment does not apply to:

(1) The device is incorrectly used or installed.

(2) Damage caused by negligence or accident during use.

(3) Modified, disassembled or repaired by other service departments not authorized by Anping Company.

2. The discharge electrode is a consumable product which is not included in the scope of warranty and will be charged for replacement when repairing.

3. AP&T shall not be liable for any incorrect use of the products except for repair or replacement of parts as specified above.

AP&T®

AP&T

Professional electrostatic intelligent monitoring/analysis
and elimination solution provider

Speciality Creates Value

Shanghai Anping Static Technology Co.,Ltd

Tel : +86-21-64517676

Fax : +86-21-64517673

Postcode : 200233

Website : www.ap-static.com

Address : 3/F, Building 27, No.69, Guiqing Road, Shanghai, China



AP&T